



Your Solutions Partner

Installation and Operation Manual

Ganged Waterless Well - Electric

Thurmaduke®

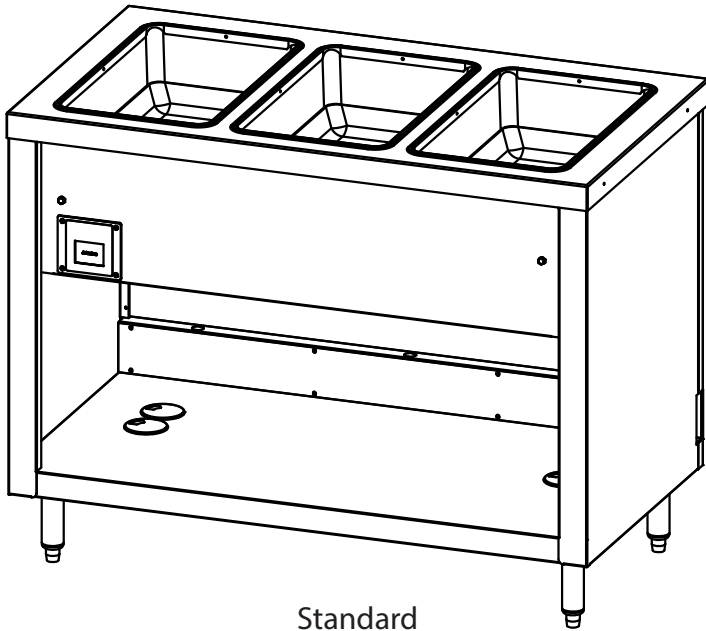

Standard

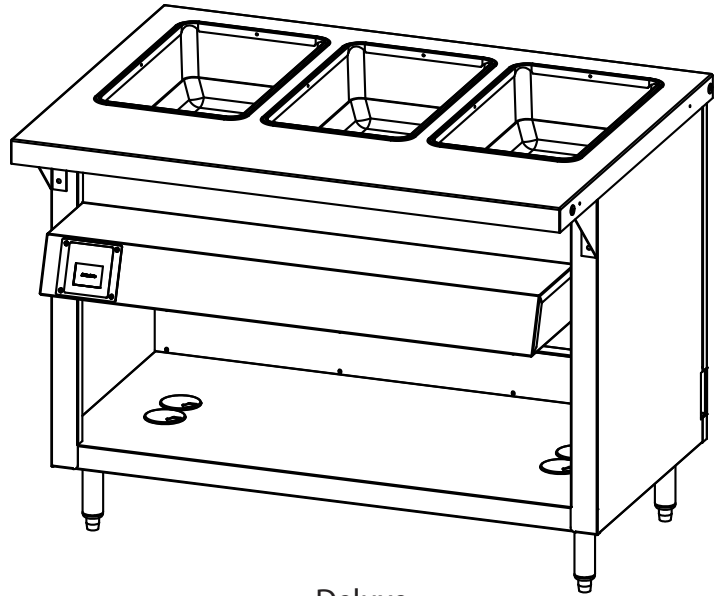

Deluxe

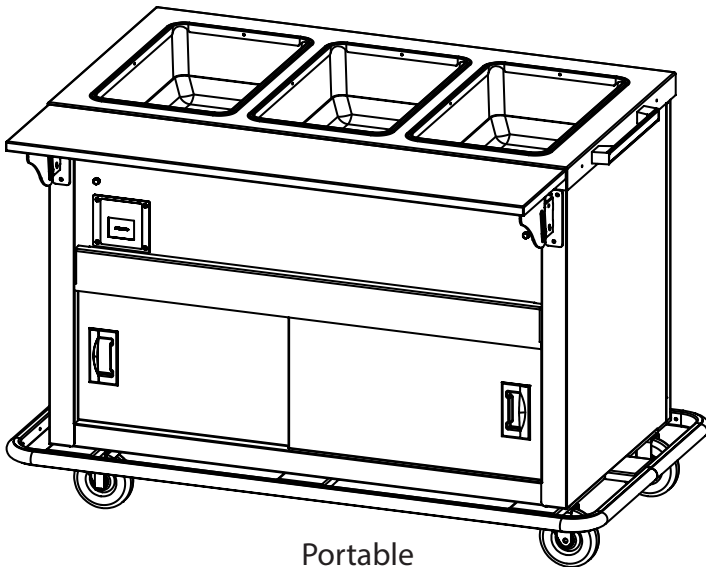

Portable



AeroServ

CAUTION: Please read this manual completely before attempting to install, operate or service this equipment



WARNING for CA residents: go to www.dukemfg.com/prop65 for prop 65 warning

This manual is Copyright © 2024 Duke Manufacturing Co. All rights reserved.
Reproduction without written permission is prohibited. Duke is a registered trademark of the Duke Manufacturing Co.

P/N 529707
REV D 01/12/2024



TABLE OF CONTENTS

Important Safety Instructions.....2-3

Receiving and Inspection of Equipment 4

General Information..... 4

General Operation Instructions..... 4

General Cleaning Instructions 4

Assembly Instruction5-7

Installation Instructions 8

Operations Instructions 9

Touch Screen Operation 10

Changing Settings 12

Maintenance 14

General Troubleshooting..... 14

Duke Stainless Steel Equipment Care And Cleaning.....14-15

IMPORTANT SAFETY INSTRUCTIONS



Improper installation, adjustment, alteration, service or maintenance can cause property damage, injury or death. Read the installation, operating and maintenance instructions thoroughly before installing or servicing this equipment.



THIS MANUAL MUST BE RETAINED FOR FUTURE REFERENCE.



Installation of this equipment should be done only by persons qualified or licensed to install electrical equipment, as per local codes.

Throughout this manual, you will find the following safety words and symbols that signify important safety issues with regards to operating or maintaining the equipment.



Indicates a hazardous situation which, if not avoided, could result in death or serious injury.



Indicates a hazardous situation which, if not avoided, could result in minor or moderate injury.



Indicates Important Information



Indicates electrical shock hazard which, if not avoided, could result in death or serious injury and/or equipment damage.



Indicates hot surface which, if not avoided, could result in minor or moderate injury.

CAUTION

Electrical shock hazard. Do not wash with water jet or hose. *IN ADDITION TO THE WARNINGS AND CAUTIONS IN THIS MANUAL, USE THE FOLLOWING GUIDELINES FOR SAFE OPERATION OF THE UNIT.*

- Read all instructions before using equipment.
- For your safety, the equipment is furnished with a properly grounded cord connector. Do not attempt to remove or disconnect the grounded connector.
- Install or locate the equipment only for its intended use as described in this manual.
- Do not use corrosive chemicals on this equipment.
- Do not use caustic cleaners, acids, ammonia products or abrasive cleaners or abrasive cloths. These can damage the stainless steel and plastic surfaces.
- Do not operate this equipment if it has a damaged cord or plug, if it is not working properly, or if it has been damaged or dropped.
- This equipment shall be serviced by qualified personnel only. Contact the nearest Duke authorized service facility for adjustment or repair.
- Do not block or cover any openings on the unit.
- Do not immerse cord or plug in water.
- Keep cord away from heated surfaces.
- Do not allow cord to hang over edge of table or counter.
- If the supply cord is damaged, it must be replaced by a special cord assembly available from Duke Manufacturing Co., or its service agent.

Note: Refer to the specifications data plate when ordering or replacing a cord set.

The following warnings and cautions appear throughout this manual and shall be carefully observed.

- Turn the unit off, disconnect the power source and allow unit to cool down before performing any service or maintenance on the unit.
- The procedures in this manual may include the use of chemical products. You must read the Material Safety Data Sheets before using any of these products.
- The unit shall be grounded according to local electrical codes to prevent the possibility of electrical shock. It requires a grounded receptacle with dedicated electrical lines, protected by fuses or circuit breaker of the proper rating, in accordance with all applicable regulations.
- This appliance is not intended for use by persons (including children) with reduced physical, sensory or mental capabilities, or lack of experience and knowledge, unless they have been given supervision or instruction concerning use of the appliance by a person responsible for their safety.
- **CAUTION:** Never use a high-pressure water wash for this cleaning procedure as water can damage electrical components
- Disposal of the unit must be in accordance with local environmental codes and/or any other applicable codes.

RECEIVING AND INSPECTION OF THE EQUIPMENT

Even though most equipment is shipped boxed or crated, care should be taken during unloading so the equipment is not damaged while being moved into the building.

Carefully check for any visible signs of damage to the cartons or containers. If evidence of damage exists, the package should be opened immediately, and a joint inventory and examination of the contents should be made by you and the driver.

CONCEALED DAMAGE

If a concealed loss or damage is discovered after you have given the carrier a clear delivery receipt, notify the carrier in writing immediately or within ten (10) days from the delivery date. If you phone the carrier, you must follow up the call in writing to protect your rights. You can only improve your position as a claimant by promptly reporting such loss or damage. You should also retain all cartons or containers, including packing material, until an inspection has been made or waived.

FILING A CLAIM

Notation of loss or damage does not constitute the filing of a claim. You should file your claim in writing with the carrier immediately!

Carriers will furnish the necessary form upon request. You should also request an inspection. If a claim is filed by phone, always follow up immediately in writing.

GENERAL INFORMATION

1. Always clean equipment thoroughly before first use. (See general cleaning instructions.)
2. Check rating label for your model designation & electrical rating.
3. For the best results, use stainless steel countertops.

GENERAL OPERATION INSTRUCTIONS

1. All foodservice equipment should be operated by trained personnel.
2. Do not allow your customers to come in contact with any surface labeled "CAUTION HOT".
3. **Never** pour water into Waterless Well units.
4. **Do not** cook, warm or hold food directly in liner pans (well pans). Always use steam table pans/insets, etc.
5. Never hold food below 150°F. Control and displays do not indicate food temperatures.
6. The Waterless Well must be full of pans during use. If any section of the well is not being used to hold product, it must be filled with an empty pan and lid.

GENERAL CLEANING INSTRUCTIONS

1. NEVER clean any electrical unit by immersing it in water.
2. Disconnect the power supply to the appliance before cleaning or servicing.
3. Always clean equipment thoroughly before first use. Clean unit daily, except where noted on charts: Use warm, soapy water. Mild cleansers and PLASTIC scouring pads may be used to remove baked-on food.
4. Turn off electrical units before cleaning or servicing.

ASSEMBLY INSTRUCTIONS FOR AEROHOT FOODWARMER UNITS

1. Place telescoping carton with printed side up and remove top. Remove foodwarmer from carton, and miscellaneous parts, etc., from heating compartments.
2. Flatten carton top and place it on floor. Place foodwarmer on the carton with top down.
3. Attach four (4) leg angles to the body by sliding the ends of the leg angles inside the body corners between body and leg plate bracket. Each leg angle is fastened with four bolts already installed, but loose.
4. Attach the undershelf to the other end of the leg angles. Use one bolt to line up and support the undershelf to the leg angles.
5. Starting at one leg angle, remove the bolt and line up with leg or caster bracket to the holes on the undershelf and leg angle. Fasten each with two bolts.
6. Repeat step "5" until all legs or casters are fastened in place.
7. At this point, the unit may be set upright. If the unit has leg brackets it should be leveled by turning the adjustable feet as needed.
8. The cutting board brackets should be attached with the screws already in place.
9. If a pusher bar has been provided, it should be attached with the screws already in place.
10. Tighten all fasteners securely.

CAUTION

UNIT IS SHIPPED UNASSEMBLED. TO MEET NATIONAL SANITATION FOUNDATION STANDARDS, THE INSTALLER MUST USE A NSF-APPROVED SILICONE SEALANT TO SEAL THE SEAMS BETWEEN THE UNIT AND ASSEMBLED PARTS

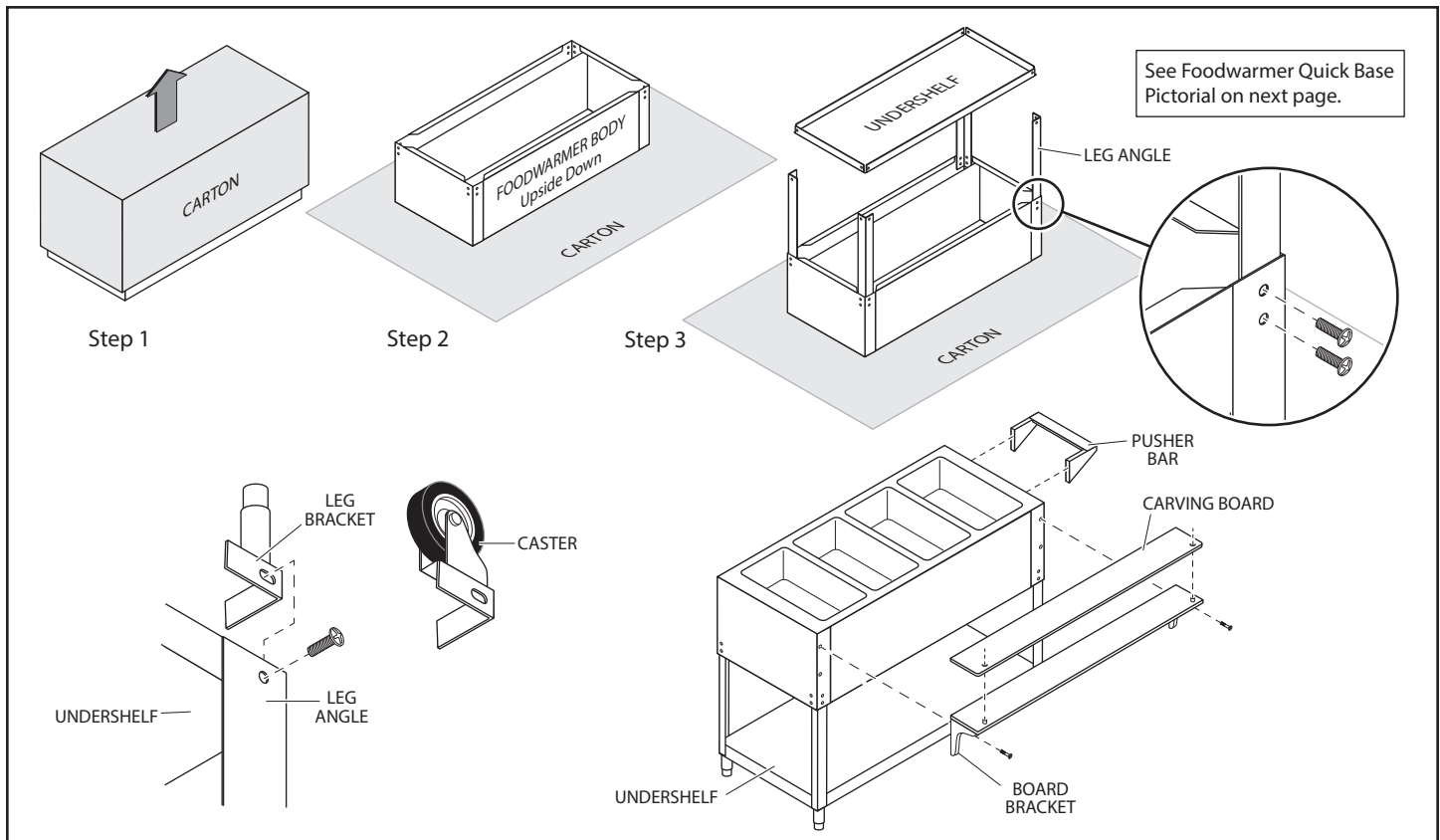

Food Warmer Quick Base

Step 1

Mount leg gussets to bottom shelf

NOTE: Leave screws loose.

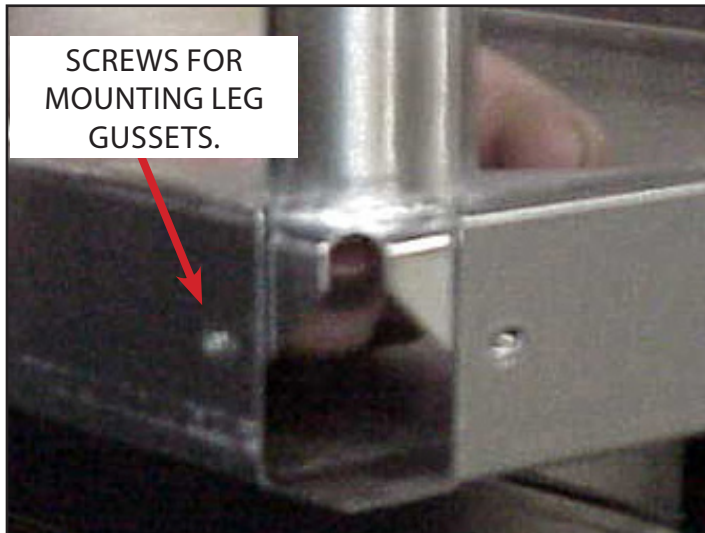

Step 3

Slide the bottom shelf over leg angle so that loose screws seat into leg angle slots.

NOTE: Tighten all screws

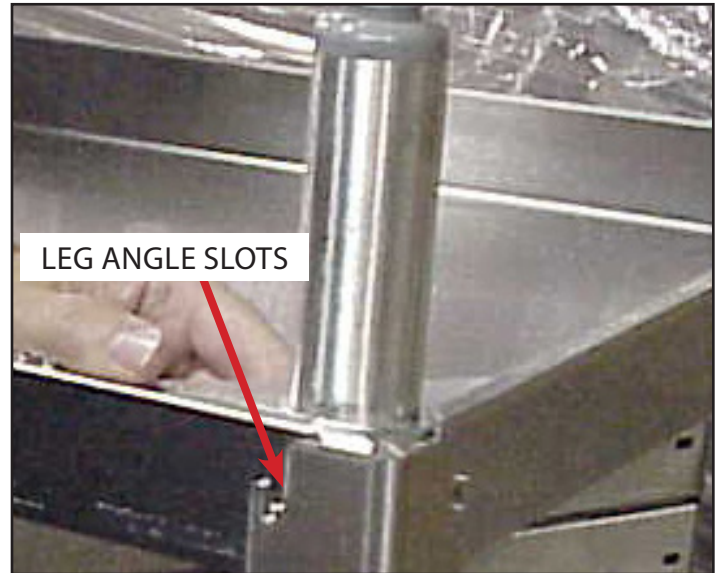

Step 2

Leg angle screws will be shipped installed in the body unit but left loose for easy leg angle insertion.

NOTE: Insert leg between unit and bracket.

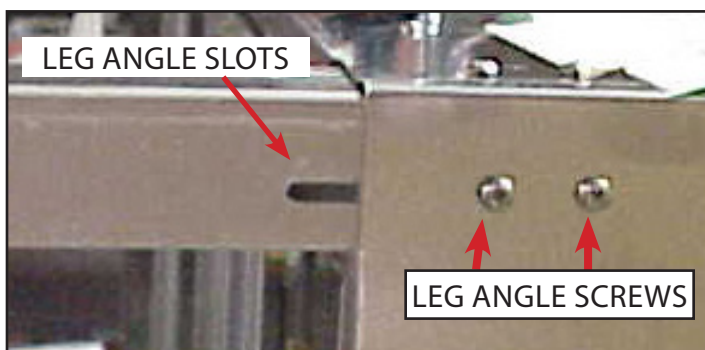

Step 4

Tighten all screw securely.

Unit is now ready to turn right side up.

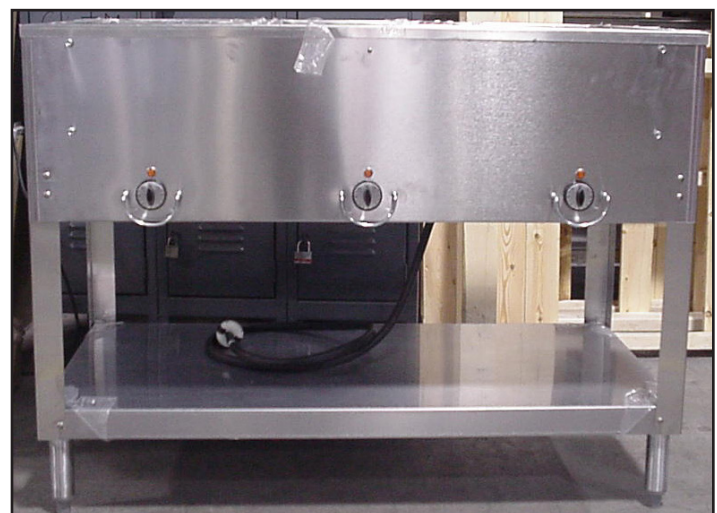

Installation of Carving Shelf

Step 1

Remove bottom carving shelf bolts and top center screw.

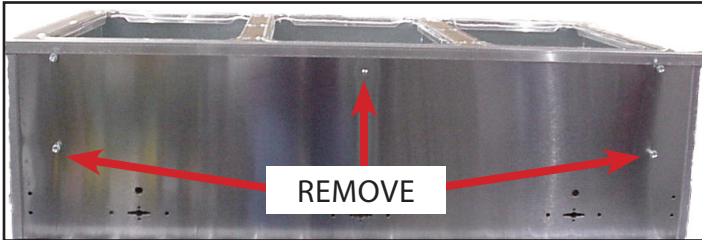

Step 5

Replace top bolts through brackets and carving shelf and into food warmer. Tighten.



Step 2

Slide carving shelf bracket over top bolt
NOTE: Flat side of bracket to outside edge of warmer.

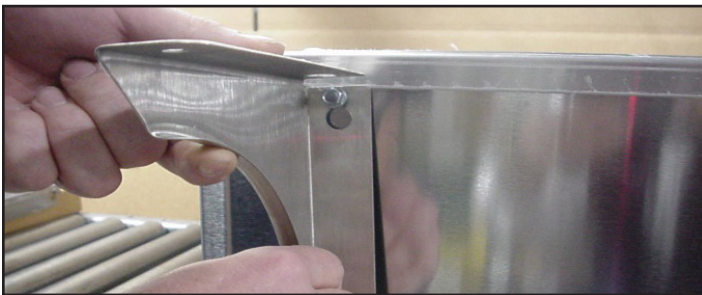

Step 6

Replace center screw through carving shelf into warmer. Tighten.

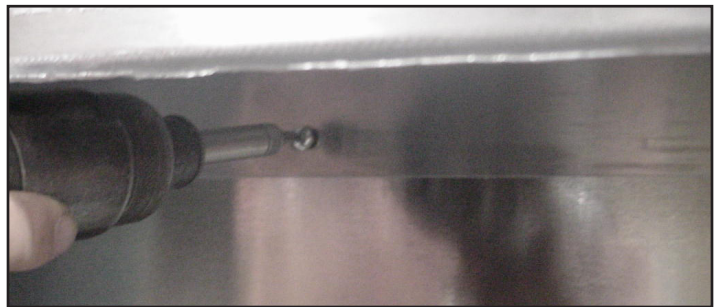

Step 3

Replace bottom carving shelf bolt and tighten.
Repeat step 2 & 3 on opposite end of warmer



Step 7

Insert position pen into corners of carving shelf and hole of support bracket. Secure with nut.



Step 4

Remove top bolts from Food warmer brackets. Place carving shelf into bracket slots.



Step 8

Place polyboard over position pens.



INSTALLATION INSTRUCTIONS

GENERAL

This foodwarmer is designed for installation as an independent heavy-duty appliance.

INSTALLATION

Operating temperatures permit safe installation of this foodwarmer within 2" of a combustible wall or partition.

Unit should be set adjusted to desired height, or to align with other equipment before it is permanently connected to electrical supply. For leveling the foodwarmer on an uneven floor or to eliminate rocking, turn the feet of the legs in the proper direction until the desired results are obtained.

ELECTRICAL CONNECTIONS

The voltage and wattage ratings of this foodwarmer are given on the device nameplate. Connect the foodwarmer to a circuit having a voltage and type of current similar to that stamped on the device nameplate. For movable equipment a proper cord and cap are included for connection to the matching power supply outlet.

For permanent installations, connections to supply line may be made through conduit or armored cable. For supply connections use No. 12 AWG or larger wires suitable for at least 90°C (194°F). Use copper wire for power supply or suitable copper to aluminum wire connector.

Supply connections are made through a knockout in the junction box. The device leads extend into the junction box for making easy connections. After making and taping connections, push excess wire back into junction box and replace cover.

The body of the appliance should be grounded by connecting the ground wire provided in the junction box to a good electrical ground, such as a water pipe, a steam pipe, or a grounded supply conduit.

The foodwarmer is not fused and consequently must be connected to a fused circuit equipped with suitable disconnect means, as required by local code authorities.

CAUTION  Check unit's electrical rating tag to ensure that electrical service is of the proper voltage and adequately sized for this equipment.

LOCATION

- Do not install the hot food unit near any combustible objects or surfaces affected by heat or moisture.

LEVELING

- This unit must be level, both front and back and left to right, in order to maintain an equal food depth throughout the wells.

NOTE: This equipment is to be installed to comply with applicable Federal, State or Local Plumbing Code.

ELECTRICAL CONNECTION

- When installed, must be electrically grounded in accordance with local codes, or in the absence of local codes, with the National Electric Code, NFPA 70, or the Canadian Electrical Code, CSA C22.2, as applicable.
- Plug unit into appropriate power receptacle.

INSTALLATION INSTRUCTIONS - continued

OPERATION

- Before the unit is used for the first time, turn each well to High and heat the well for 20-30 minutes. Do not be alarmed if smoke appears; this preheat should burn off any residue or dust on the heating elements.

⚠ WARNING Steam can cause serious burns. Always wear some type of protective covering on your hands and arms when removing lids or pans from the unit. Lift the lid or pan in a way that will direct escaping steam away from your face and body.

- Never place food directly into the well. Always use pans.
- Always place covers on pans when not serving to prevent food from drying out and to reduce your operating costs.
- For most efficient operation, keep empty, covered insets in each well during preheating and when the well is not in use.

OPERATING THE FOODWARMER

PREHEAT

***DO NOT* add water. This unit is not designed to function with water in the well.**

- To preheat individual sections, set each well to high for 10 - 20 minutes before any foods are placed in the compartments. Insure that pan openings are covered to prevent loss of heat.

DRY OPERATION

- After pre-heating, set the control to your desired serving temperature.
- This unit has been designed to hold and maintain your hot products to the NSF4 standard. The appropriate settings must be used to maintain these temperatures.
- Individual wells can be expected to reach set point temperature within 15-to-20 minutes of being turned on.
- Keep well covered during pre-heating or when not in use or serving food.
- The Waterless Well must be full of pans during use. If any section of the well is not being used to hold product, it must be filled with an empty pan and lid.

ECONOMY OF OPERATION

Air, being easier and quicker to heat than water, makes the waterless foodwarmer faster and more economical to operate than a table using water.

Foods can be kept moist by keeping them at the correct temperature. Foods dry out only when excessive temperatures are reached, so when foods tend to dry out, **REDUCE HEAT.**

If only part of the foodwarmer is needed, the compartment not in use need not be heated. Insulation between the compartments divide the unit into a series of smaller independent food warmers.

OPERATING THE FOODWARMER

CARE AND CLEANING

Care should be used to prevent spilling when placing full food containers into the pan openings. Spilled foods that are not removed will dry out and eventually burn, causing odors. The inside of the heating compartments should be wiped out daily and thoroughly cleaned at least once each week.

TEMPERATURE SETTINGS

The most satisfactory control settings must be determined by experience based on the nature of the foodservice and the type of operation as well as individual preference of the restaurant operator. The proper setting are necessary to keep foods at the desired temperature will vary dependent upon the frequency of turnover, size of food containers, amount of food in each container, room temperature, location of foodwarmer with respect to range or other heated equipment, air outlets, fans, doors and passageways.

Display Settings	Recomended Temperatures (in degrees)	FOODS OR TYPES OF FOODS
Lo	140° - 150°F	Rolls - Thick Soups Creamed Foods - Mashed Potatoes
Med	150° - 170°F	Roasts* - Short Ribs - Sliced Meats Baked Ham* - Fish - Vegetables - Cutlets Stews - Baked Beans - Croquettes Fried Liver - Fried Potatoes Fried Chicken Medium Gravies
Hi	170° - 200°F	Baked Potatoes - Barbecued Ribs Dressing - Thin Gravies and Soups

* A low perforated rack is recommended to keep roasts and hams off the bottom of the pan. When a rack is used, keep 1" - 2" of thin gravy in the bottom of the pan.

TOUCH SCREEN OPERATION

1 Press power button icon on screen to turn on unit.

2 The main runtime screen will appear. If the unit contains more than one well, the screen will show an icon for each well. On a multi-well unit, press an icon for a well to turn on.

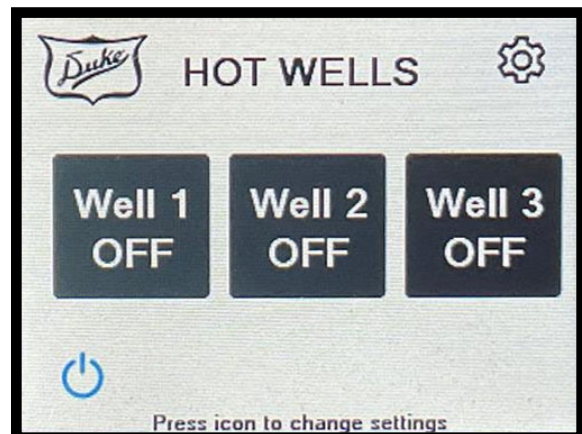
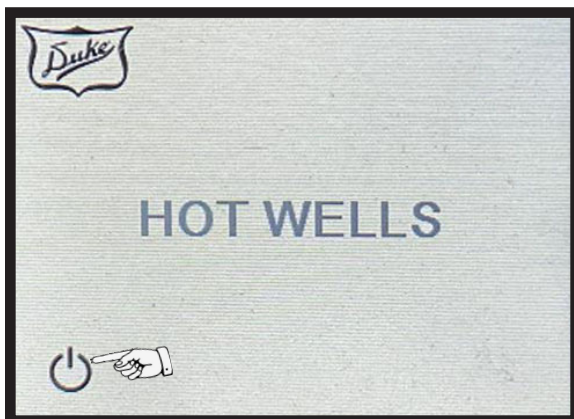

On a multi-well unit, press the ON/OFF icon to turn ON/OFF an individual well.

TOUCH SCREEN OPERATION

3 Press the icon for the temperature level required. The bottom of the screen will indicate well status. Press the back arrow in the top right corner to return to the main screen.

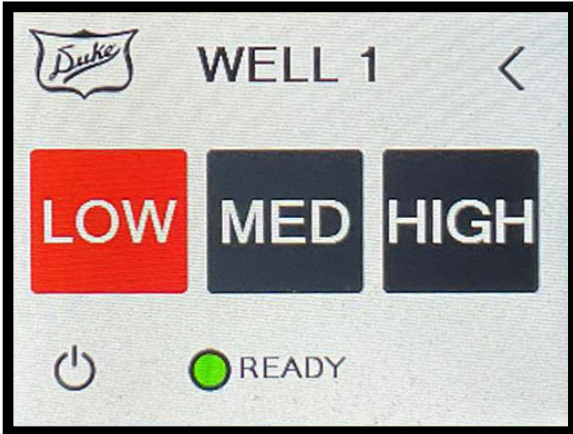

6 To turn off a single well, press the ON/OFF icon on that wells display page. The display will return to the main page.

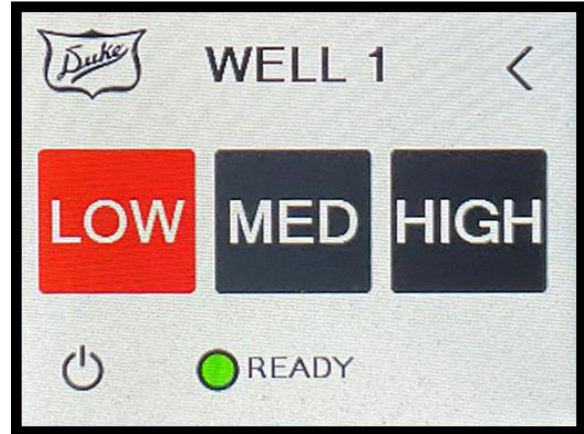

4 The icon for the well will indicate the status of the well.

Note: To turn off all wells at once go to the main page and press the ON/OFF Icon.

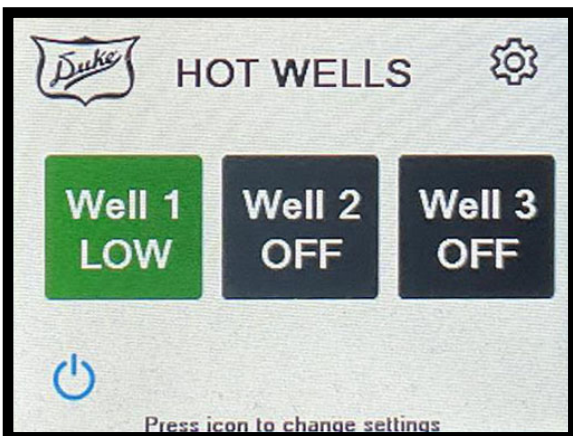

7 If a fault has occurred, the status message will indicate "FAULT"



5 Repeat step two (2) thru four (4) for additional wells.

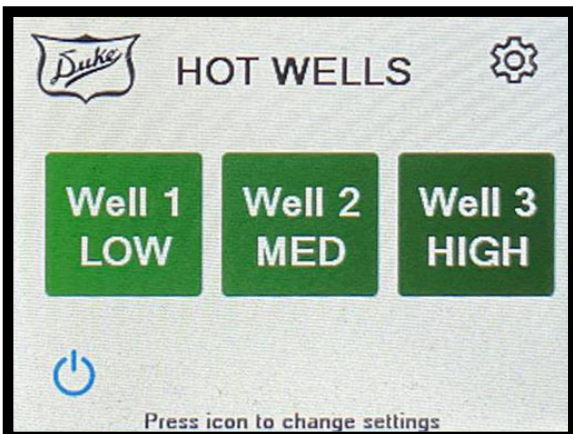

CHANGING SETTINGS

1 Select the **settings icon**. This will take you to the general settings screen

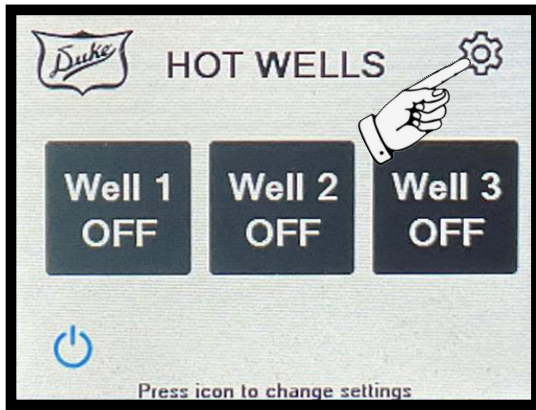

2 In the General Settings screen select **Tools**.

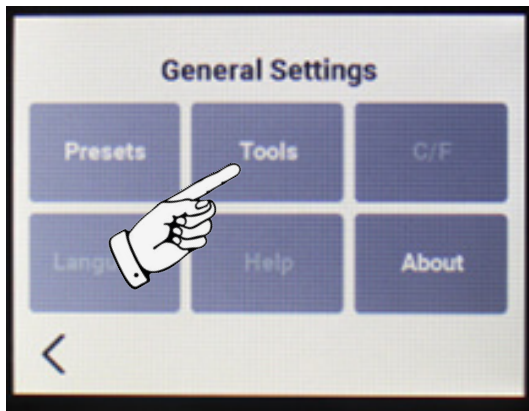

3 In the tools screen selects **Admin**

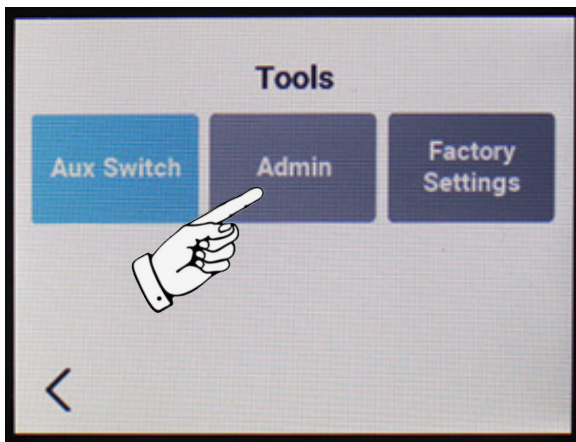

4 Enter Code 0654 for the **PIN Code**

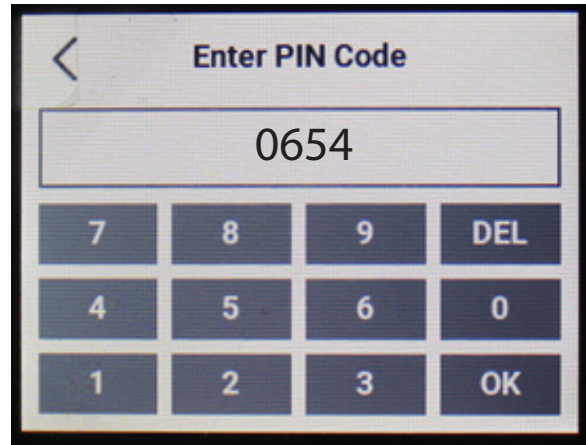

5 By default Presets will be "Locked"
Slide the toggle to the unlock position and select the check mark this will take you back to the General Settings Screen.

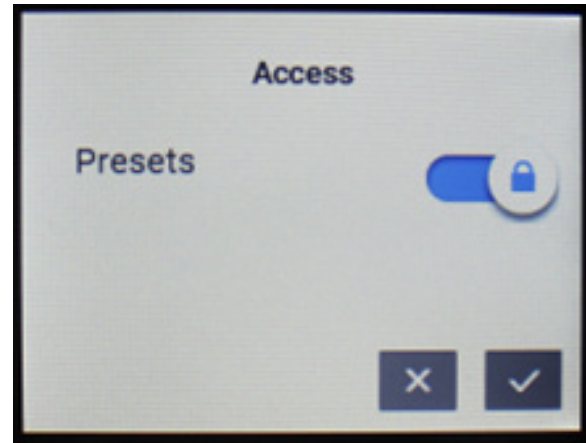

6 Now select Presets.

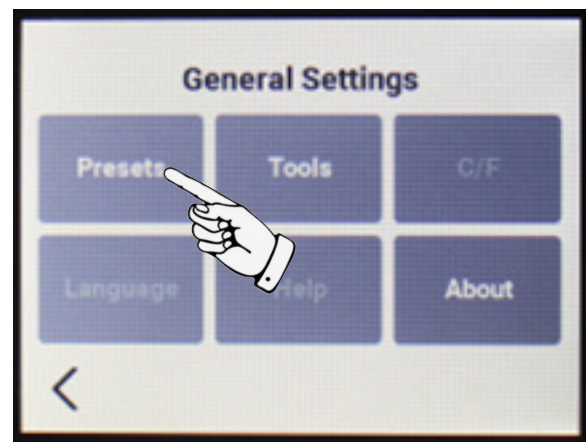

CHANGING SETTINGS

7 The 3 current presets will be displayed. Low, Medium and High. To edit one of the presets select the edit icon next to the appropriate preset in the Actions column.

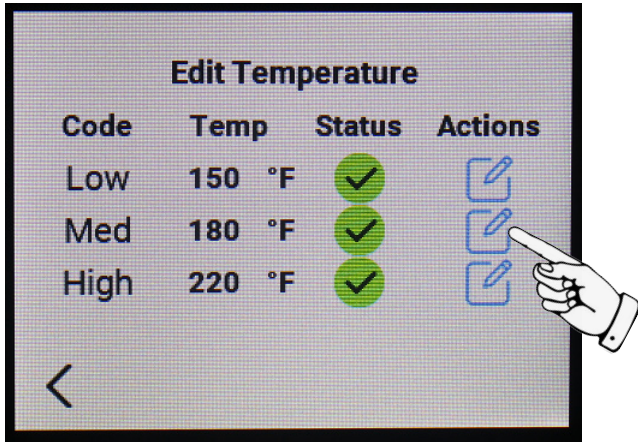

9 Return to the Access screen and lock the presets.

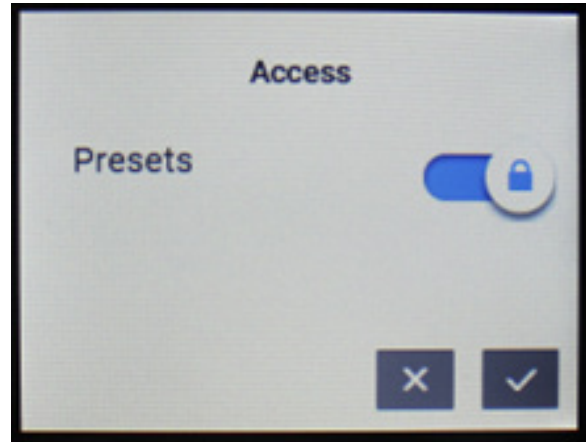

8 Use the Plus and Minus buttons to modify the Temperature. The temperature will decrease or increase by 1 with each button press. When done select the **CHECK** button to save or the **X** to cancel.
NOTE: Temperature is a setpoint, NOT food temperature.

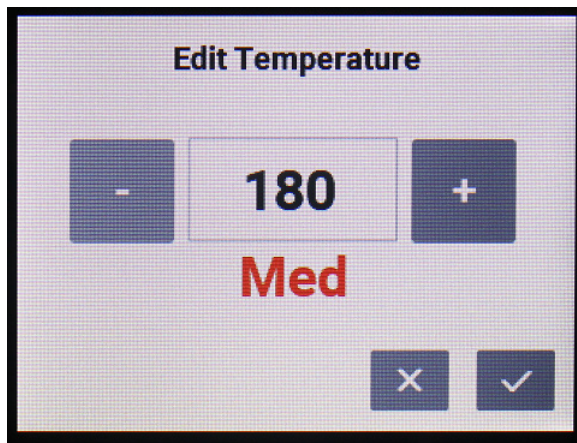

10 Return to the main screen. The new set point will now be used for the appropriate runtime screen.

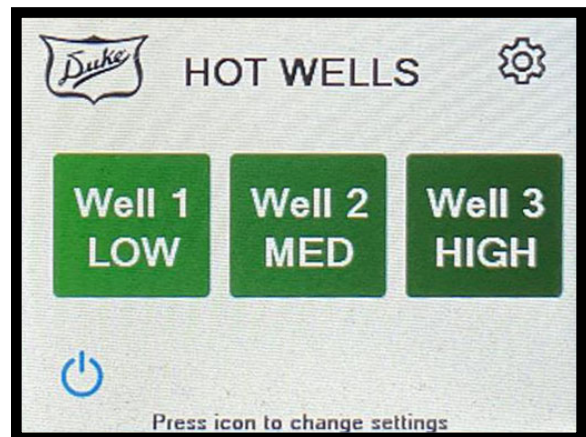

MAINTENANCE

DAILY CLEANING

- Turn the control to the OFF position and allow unit to cool before cleaning.
- Use a soft cloth or sponge with a mild detergent to clean the entire warmer assembly. Rinse completely with warm water and then dry.
- A plastic scouring pad and a mild detergent may be used to remove hardened food.

⚠ WARNING Do not use steel wool.

⚠ WARNING

Do not use any highly caustic cleaners, acids or ammonia. These may cause corrosion and/or damage to the stainless steel well. Do not allow water to stand in the well for long periods of time.

GENERAL TROUBLESHOOTING

Always ask and check:

1. Is the unit connected to a live power source?
2. Check circuit breaker.
3. Is the control on?
4. Check rating label. Are you operating the unit on the proper voltage?

DUKE Stainless Steel Equipment Care and Cleaning

Contrary to popular belief, stainless steels are susceptible to rusting. Corrosion of metals is everywhere. It is recognized quickly on iron and steel as unsightly yellow/orange rust. Such metals are called “active” because they actively corrode in a natural environment when their atoms combine with oxygen to form rust.

Stainless steels are passive metals because they contain other metals, like chromium, nickel and manganese that stabilize the atoms. 400 series stainless steels are called ferritic, contain chromium, and are magnetic; 300 series stainless steels are called austenitic, contain chromium and nickel; and 200 series stainless, also austenitic, contains manganese, nitrogen and carbon. Austenitic types of stainless are not magnetic, and generally provide greater resistance to corrosion than ferritic types.

With 12-30 percent chromium, an invisible passive film covers the steel's surface acting as a shield against corrosion. As long as the film is intact and not broken or contaminated, the metal is passive and stain-less. If the passive film of stainless steel has been broken, equipment starts to corrode. At its end, it rusts.

Enemies of Stainless Steel

There are three basic things which can break down stainless steel's passivity layer and allow corrosion to occur:

- **Mechanical abrasion**
- **Deposits and water**
- **Chlorides**

Mechanical abrasion means those things that will scratch a steel surface. Steel pads, wire brushes and scrapers are prime examples.

Water comes out of the faucet in varying degrees of hardness. Depending on what part of the country you live in, you may have hard or soft water. Hard water may leave spots, and when heated leave deposits behind that if left to sit, will break down the passive layer and rust stainless steel. Other deposits from food preparation and service must be properly removed.

DUKE Stainless Steel Equipment Care and Cleaning- continued

Chlorides are found nearly everywhere. They are in water, food and table salt. One of the worst chloride perpetrators can come from household and industrial cleaners.

So what does all this mean? Here are a few steps that can help prevent stainless steel rust:

1. Use the proper tools.

When cleaning stainless steel products, use non-abrasive tools. Soft cloths and plastic scouring pads will not harm steel's passive layer. Stainless steel pads also can be used but the scrubbing motion must be in the direction of the manufacturers' polishing marks.

2. Clean with the polish lines

Some stainless steel comes with visible polishing lines or "grain." When visible lines are present, always scrub in a motion parallel to the lines. When the grain cannot be seen, play it safe and use a soft cloth or plastic scouring pad.

3. Use of alkaline, alkaline chlorinated or non-chloride containing cleaners.

While many traditional cleaners are loaded with chlorides, the industry is providing an ever-increasing choice of non-chloride cleaners. If you are not sure of chloride content in the cleaner used, contact your cleaner supplier. If your present cleaner contains chlorides, ask your supplier if they have an alternative. Avoid cleaners containing quaternary salts; it also can attack stainless steel and cause pitting and rusting.

4. Treat your water.

Though this is not always practical, softening hard water can do much to reduce deposits. There are certain filters that can be installed to remove distasteful and corrosive elements. To insure proper water treatment, call a treatment specialist.

5. Keep your food equipment clean.

Use alkaline, alkaline chlorinated or non-chloride cleaners at recommended strength. Clean frequently to avoid build-up of hard, stubborn stains. If you boil water in stainless steel equipment, remember the single most likely cause of damage is chlorides in the water. Heating cleaners that contain chlorides have a similar effect.

6. Rinse, rinse, rinse.

If chlorinated cleaners are used, rinse and wipe equipment and supplies dry immediately. The sooner you wipe off standing water, especially when it contains cleaning agents, the better. After wiping equipment down, allow it to air dry; oxygen helps maintain the stainless steel's passivity film.

7. Never use hydrochloric acid (muriatic acid) on stainless steel.

CLEANING PROCEDURES FOR CARVING BOARDS

When high pressure cleaning equipment is not available; use hot water, a granular cleanser or detergent and a stiff bristle brush. (Abrasive action is necessary, as simply wiping the board will not suffice.) After scrubbing, rinse thoroughly with hot water. Allow to lie flat.

Several excellent germicidal cleaners are also available, including Calgon's "Big Cat" and Johnson's "Break Up". Clorox is another good cleaner and is USDA approved.

The tabletop material is cut into sections not larger than 36" in any plane, and no section weighs more than fifty (50) pounds. These are stipulations of the National Sanitation Foundation to facilitate cleaning.

The tops should be turned over daily to reduce possibility of warping and should never be stood on end.

Periodically, go over the board with a clean, flat stainless steel scraper to help seal some of the knife marks. The use of cleavers on synthetic boards or tabletops is not recommended.



Duke Manufacturing Co.
2305 N. Broadway
St. Louis, MO 63102

Phone: 314-231-1130
Toll Free: 1-800-735-3853
Fax: 314-231-5074

www.dukemfg.com